



DaoSafe

DS7100 Speed Gate

SINGLE / BI-DIRECTION

SAFETY
LEVEL

AESTHETICS

COSTING

Description

- DS7100 Speed gate is designed for elegant and luxury application to control access.
- Outstanding feature: 0.1s fast open and close speed, 55 people support to pass per minute which is usually used in high pedestrian traffic flow in both directions.
- The top tempered glass swipe window, the side tempered glass, black with a line of infrared induction, attractive fashion.
- 120mm slim body housing is made of brushed stainless steel which is robust, rigid, anti-rust, waterproof and durable.
- The passing width can reach to 600mm for normal passage, and can support ≤ 1000 mm arm for wide passageway, wheelchair, and pedestrian with large luggage can also pass.
- Superior production: Integrated mold production to ensure the high quality guaranteed.
- Welding: adopt robot for weld to improve the high technological level.
- It has standard relay signal, which can be integrated with any kind of third-party access control system (e.g.: RFID, Fingerprint and Biometric reader device).
- In case of emergency, the arms will open automatically to allow free passage when power off.
- It is suitable for areas with general pedestrian traffic (e.g.: Hotel, Gym, Building, Bank, Shopping mall, Reception Area and so on).

Features

- ✓ Long-life performance, high operation dependability and fast response.
- ✓ The whole system runs smoothly, low noise, no mechanical impact.
- ✓ Single directional or Bi-directional is selectable.
- ✓ Automatic reset function: swing arms will lock automatically within 5s (can be setting) if passenger delay to entry.
- ✓ When power is off, swing arms will open automatically, which is complying with fire safety requirements.
- ✓ LED indicator (red × means no entry; green → means entry).
- ✓ Infrared sensor alarm function, in case of illegal intrusion and reverse intrusion.
- ✓ Anti-intrusion function, the speed gate is locked automatically until valid opening signal input.
- ✓ Anti-reverse function, the turnstile alarms if someone wants to entry in the reverse direction.
- ✓ Anti-trailing function, the speed gate alarms if someone wants to burst in without permission.
- ✓ Anti-collision and anti-kick function, it designed with consolidated and more durable mechanism, will not break even someone collide it.
- ✓ Mechanism self-protection: the arm will reset automatically if is off position. It's movement will not be broken or damaged even after hit.
- ✓ It has the fastest open and close speed rate, 0.1 second. The open and close speed rate can be adjusted.
- ✓ Easy to install and maintain.
- ✓ 3-year warranty support.



Speed gate with card solution



speed gate with 0.1s fast open and close speed, 55 people support to pass per minute which is usually used in high pedestrian traffic flow in both directions.

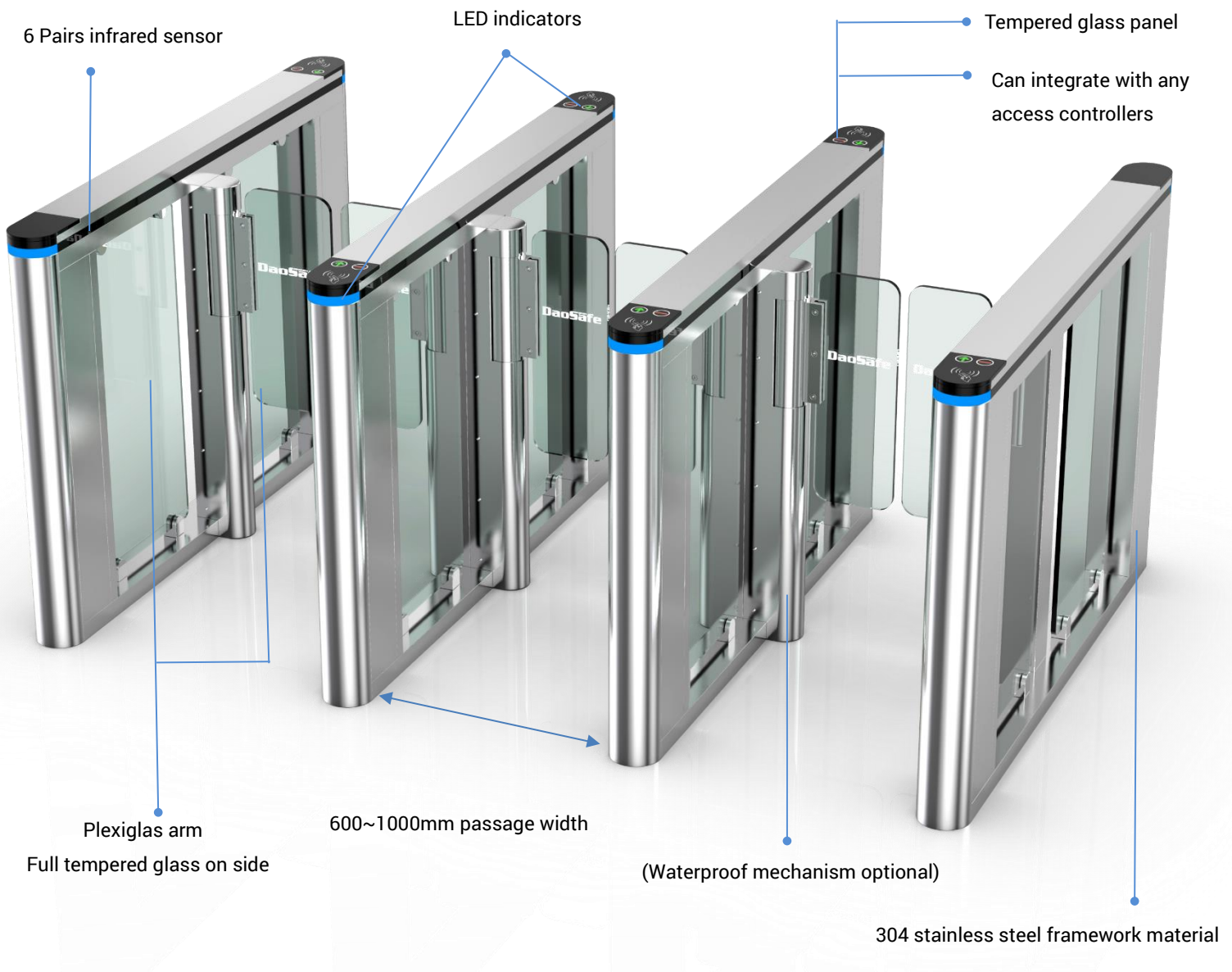

DS7100 HIGHLIGHTS

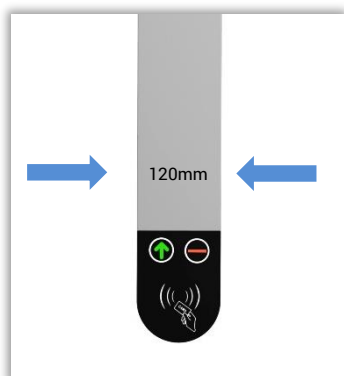

120mm brushed stainless steel slim cabinet

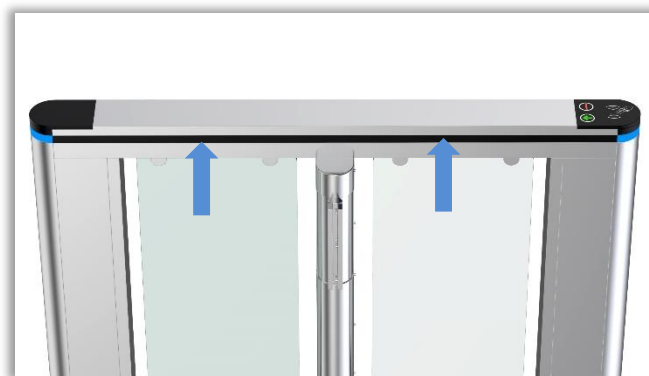

Infrared sensor in the line of the black area



Tempered glass swipe window with red and green led light

Specification

Model No.	DS7100
Type	Speed Gate
Brand	Daosafe
Certification	Compliance CE, FCC
Communication	Dry contact, Relay signal, RS485
Framework Material	304 Stainless Steel+ Plexiglas Arm+ Full Tempered Glass on side
Arm material	Plexiglas–transparency
Dimension	1500 * 120 * 1020mm
Net Weight	80kg/pcs (single core), 100kg/pcs (double core)
Passage Width	600mm (standard), 1000mm (handicap)
Passing Direction	Single directional / Bi-directional
MCBF	15 million
Power Supply	AC220V/110V, 50/60Hz
Operation Voltage	24V DC
Power Consumption	90–100W
Operation Temperature	-20 °C – 75 °C
Operation Humidity	0 ~ 95% (No freeze)
Working Environment	Indoor / Outdoor (shelter)
Flow Rate	55 people per minute
LED Indicator	Two LED indicators on top: green → entry. red × no entry
Infrared Sensor	6 pairs(standard)
Open Solution	Card, QR, Face, or Infrared

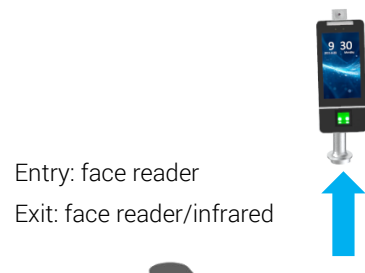
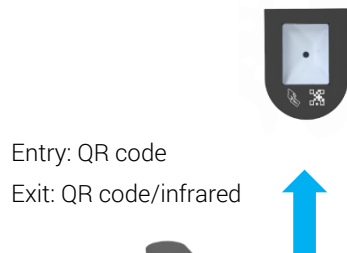
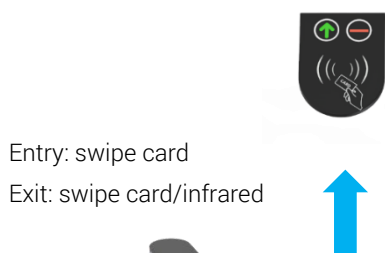

Speed Gate Dimension

STANDARD: 600mm

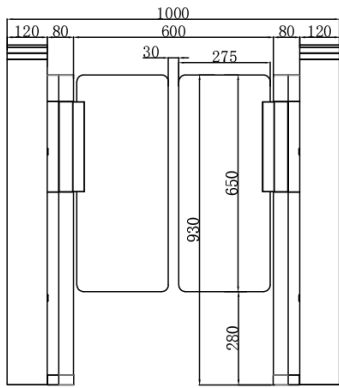

Front View

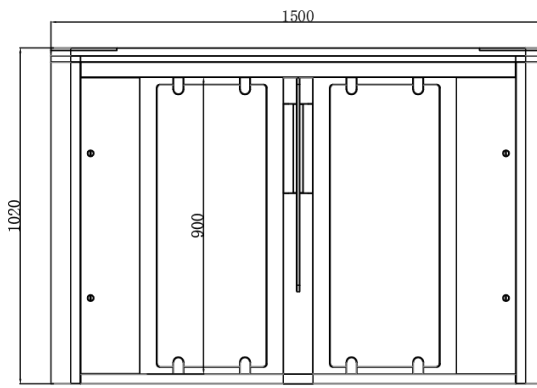

Side View

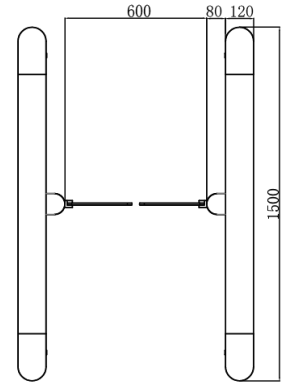

Top View



STANDARD + HANDICAPPED: 600mm+900mm

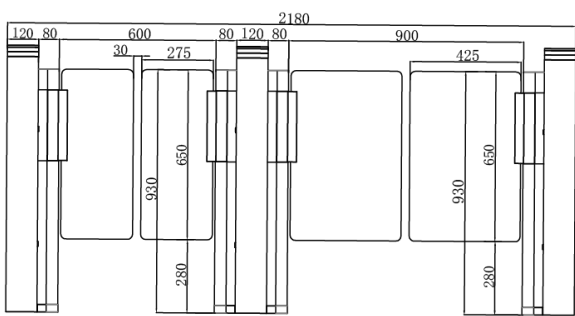

Front View

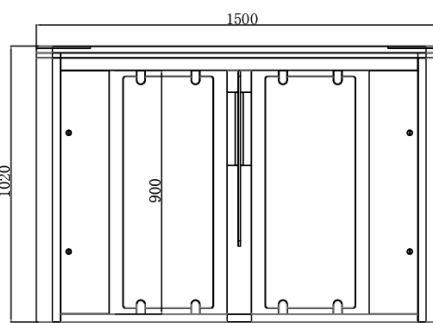

Side View

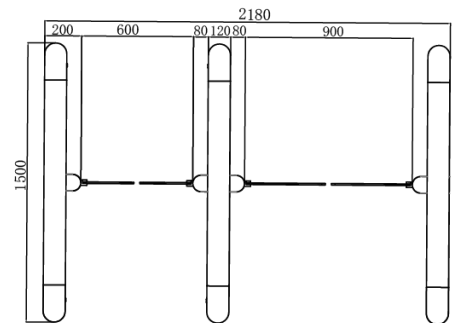

Top View



Integrate With Any Access Control

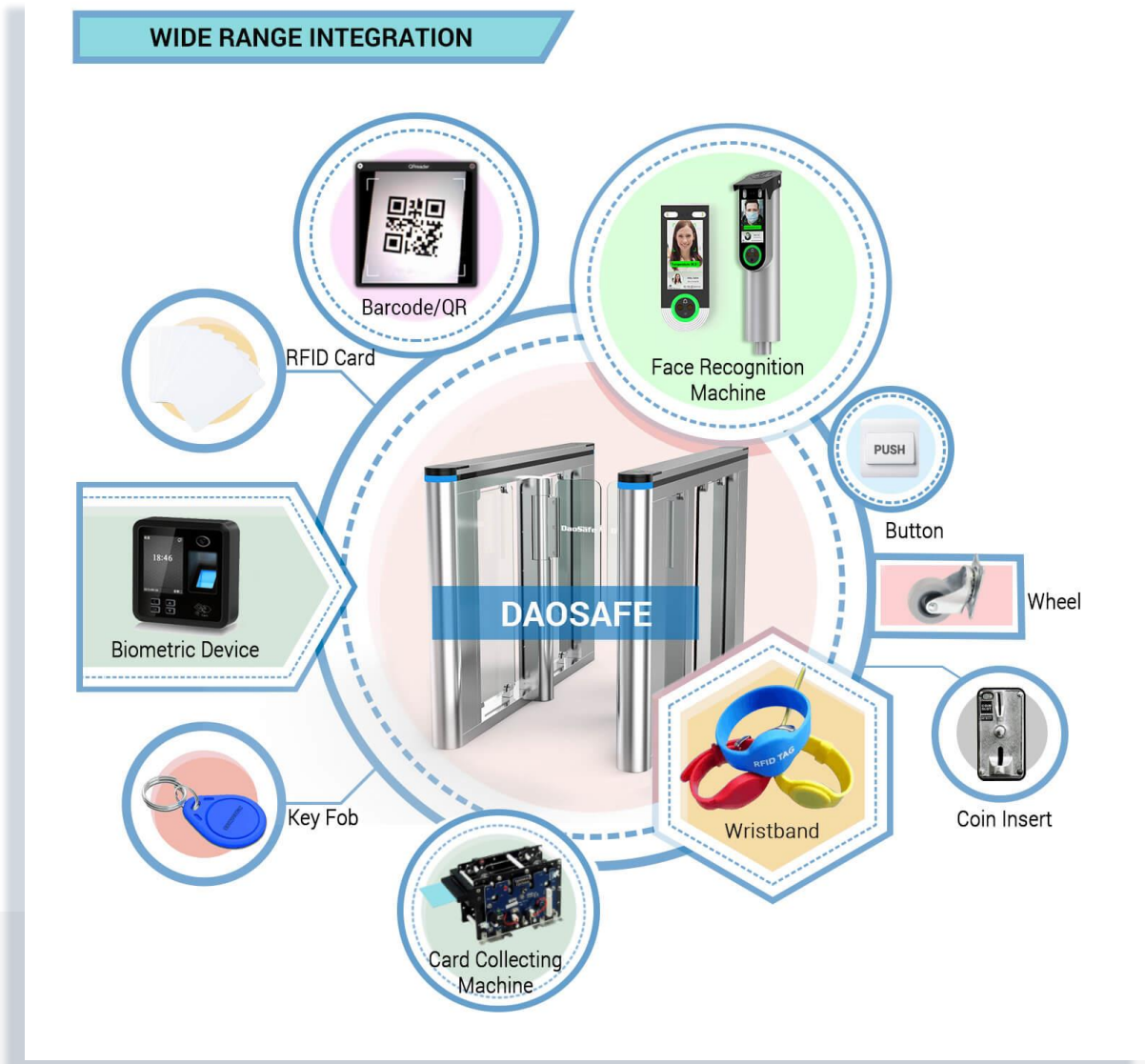

- **Face Recognition**
Dynamic face recognizes, non-contact and trendy solutions
- **Barcode /QR scanner**
Connect with mini PC or access controller to use
Support phone or paper Barcode/QR
- **RFID Card**
All kinds of RFID card reader, such as
Mifare, EM cards, HID card, Key Fob, Wristband...
- **Biometric Device**
Support Fingerprint, RFID card, password
Popular and secure access control solutions
- **Key Fob**
RFID type, mainly use in apartment
- **Card Collector Machine**
The solution is mainly used in park, building for visitor
- **Wristband**
RFID type, mainly used in swing pool and gym
- **Coin Insert**
The solution is mainly for bus stations or toilet
- **Wheel**
Integrated on turnstile for movable and portable
- **Button**
Exit by freely passing/ push button
- **3rd Party Access Controller**
Any 3rd party access controller can integrate with all our turnstiles

Speed gate handicap solution



speed gate passing width can reach to 600mm for normal passage, and can support $\leq 1000\text{mm}$ arm for wide passageway, wheelchair, and pedestrian with large luggage can also pass.

Speed gate face recognition solution



speed gate has standard relay signal, support the integrated with DS-F85T for face recognition access control solution.

System Integration Figure

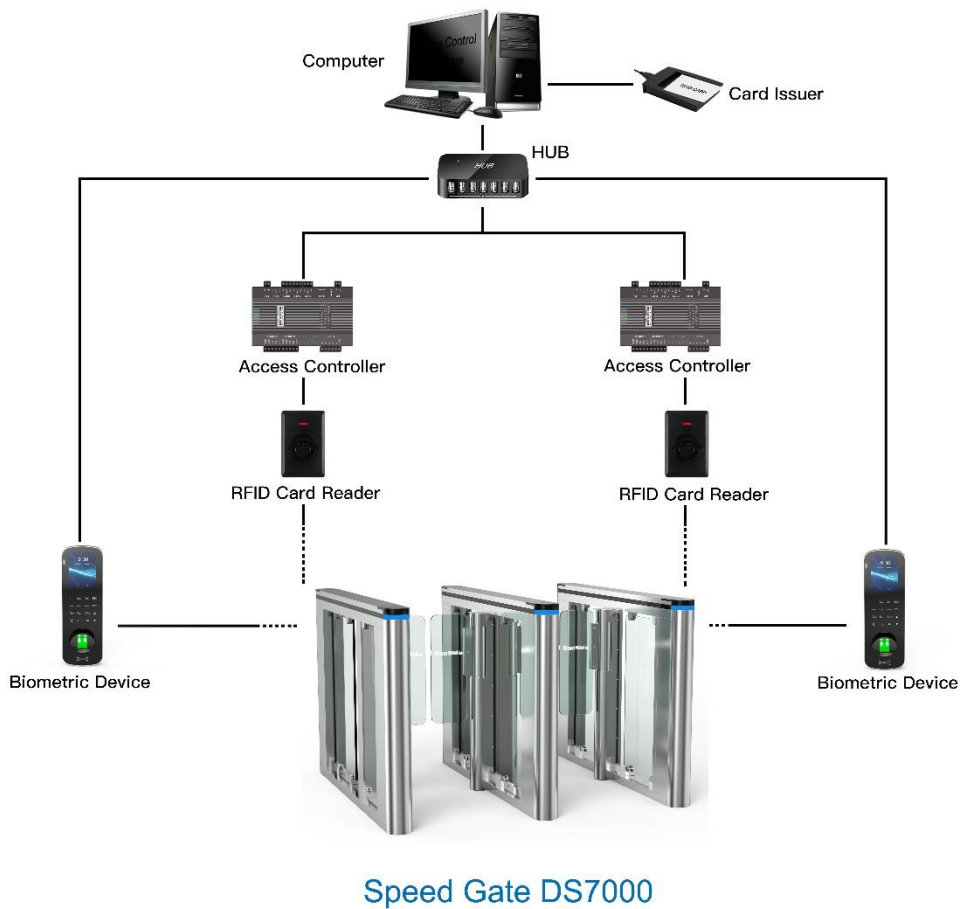

REMARK:

- The turnstile circuit board support to work with any relay signal, and support to integrated with any 3rd party access control system: RFID, BIOMETRIC, QR/BARCODE and so on.
- Multiple access controller board can be connected by TCP/IP through net cable, control by central computer.
- The turnstile circuit board is also with RS232 output, it can connect with mini PC. Turnstile will open once received simple code by computer, which is suitable for the complicated like ticketing system solution.

Speed gate is designed for elegant and luxury application to control access.

Outstanding feature: 0.1s fast open and close speed, 55 people support to pass per minute which is usually used in high pedestrian traffic flow in both directions.



One Lane



Two Lanes



Three Lanes