



MODEL DS411
SINGLE DOOR

SAFETY
LEVEL

AESTHETICS

COSTING

Description

- Full height turnstile is highest safety access control solutions.
- The body is made of brushed stainless steel which is robust, rigid, anti-rust, waterproof and durable.
- It is ideal for both indoor and outdoor settings.
- It has standard relay signal, which can be integrated with any kind of third-party access control system (e.g.: RFID, Fingerprint and Biometric reader device).
- It supports any type of external device solution. (e.g.: Display, Counter, Reader, Face recognition, Push button, Card collector, RFID Wristband Collector, Coin insert, Barcode/QR reader, Wheel).
- In case of emergency, turnstile gate will open automatically to allow free passage when power off.
- Anti-tailing function: only one person passes at one time.
- It is suitable for areas with high security. (e.g.: Embassy, Stadium, Bank, Jail, Oil Field, Construction site, Station).

Features

- ✓ Long-life performance, high operation dependability and fast response.
- ✓ Override key function: when emergency, can control turnstile open/close manually.
- ✓ The mechanism is equipped with an automatic regulated hydraulic buffer device. No noise and impact when running
- ✓ Single directional or Bi-directional is selectable.
- ✓ Automatic reset function: turnstile arm will lock automatically within 5s (can be setting) if passenger delay to entry.
- ✓ LED indicator (red × means no entry; green → means entry).
- ✓ Structure of trunking to contain cable tidy inside the case.
- ✓ Structure of arm with round stainless-steel end cover.
- ✓ Easy to install and maintain.
- ✓ 3-year warranty support.

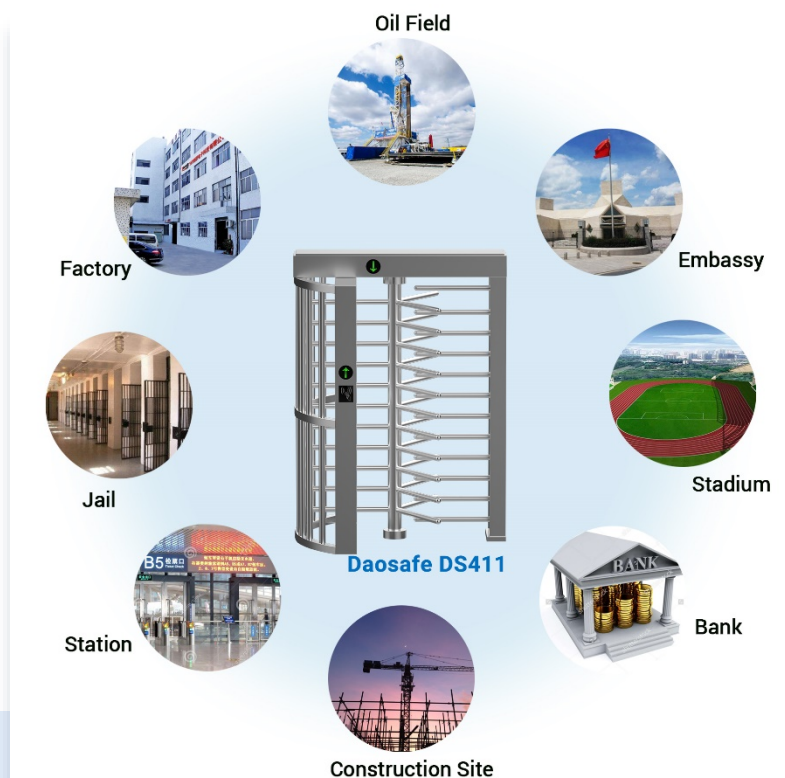

We don't only offer turnstile gates

We offer full access control solutions



RFID CARD

All kinds of RFID card reader, such as Mifare, EM cards, HID card



QR, Barcode scanner

Integrate mini PC or access controller with barcode scanner



3rd Party Access Controller

Any 3rd party access controller can integrate with all our turnstiles

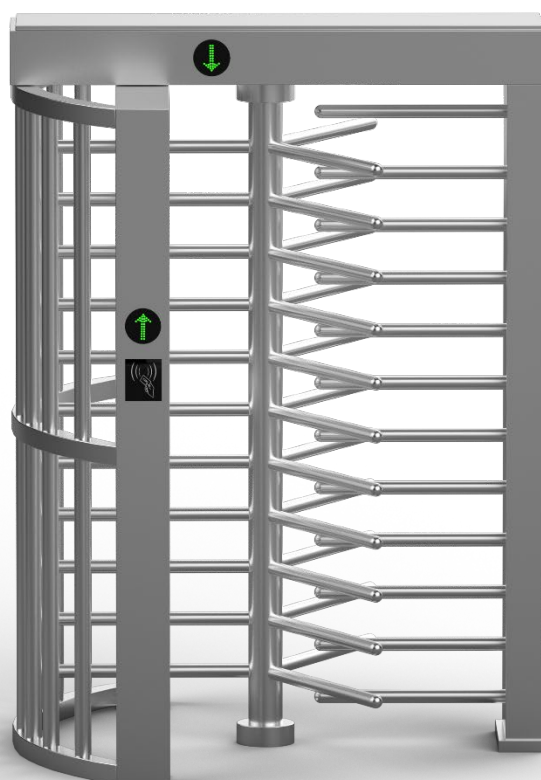

Fingerprint Device

Popular and secure fingerprint access control solutions



Face Recognition

Efficient and trendy face recognition solutions



Coin Collector

Coin collector solutions for bus stations or toilet



Specification

Model No.	DS411
Type	Full Height Turnstile
Brand	Daosafe
Framework Material	304 full stainless steel
Arm Support	120° rotors with 3 sections or 90° rotors with 4 sections
Dimension	1460 * 1250 * 2180mm
Net Weight	180kg/pcs
Passage Width	1 lane, 650mm/lane
Passing Direction	Single directional / Bi-directional
MCBF	5 million
Power Supply	AC220V/110V, 50/60Hz
Operation Voltage	24V DC
Power Consumption	40W
Operation Temperature	-15 °C – 60 °C
Operation Humidity	0 ~ 95% (No freeze)
Working Environment	Indoor / Outdoor
Flow Rate	35-40 people per minute
LED Indicator	Yes
Emergency	Automatic arm open when power off
Communication	Dry contact, Relay signal, RS485

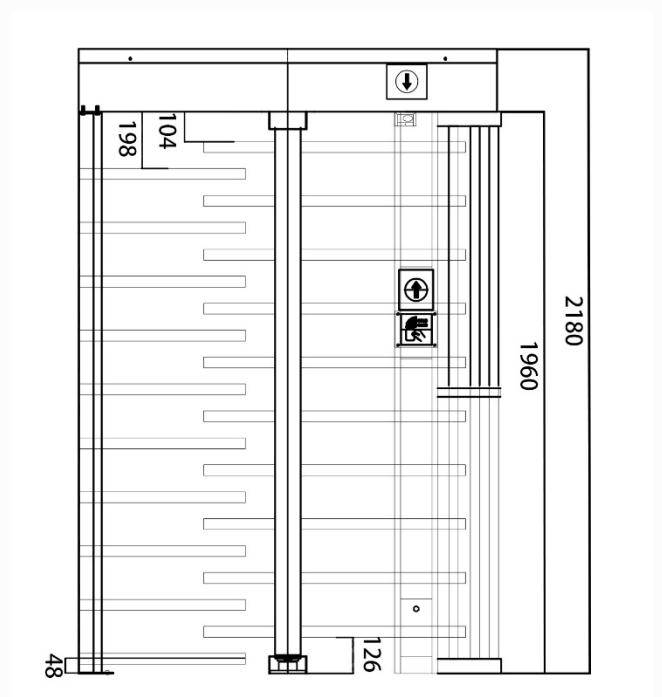
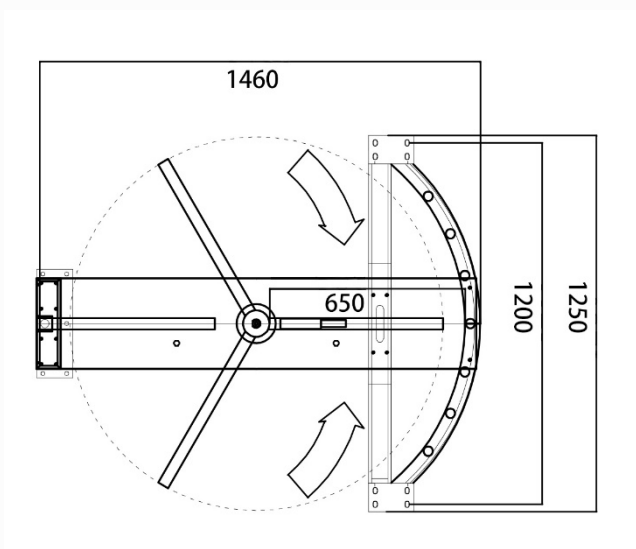

WIDE RANGE INTEGRATION

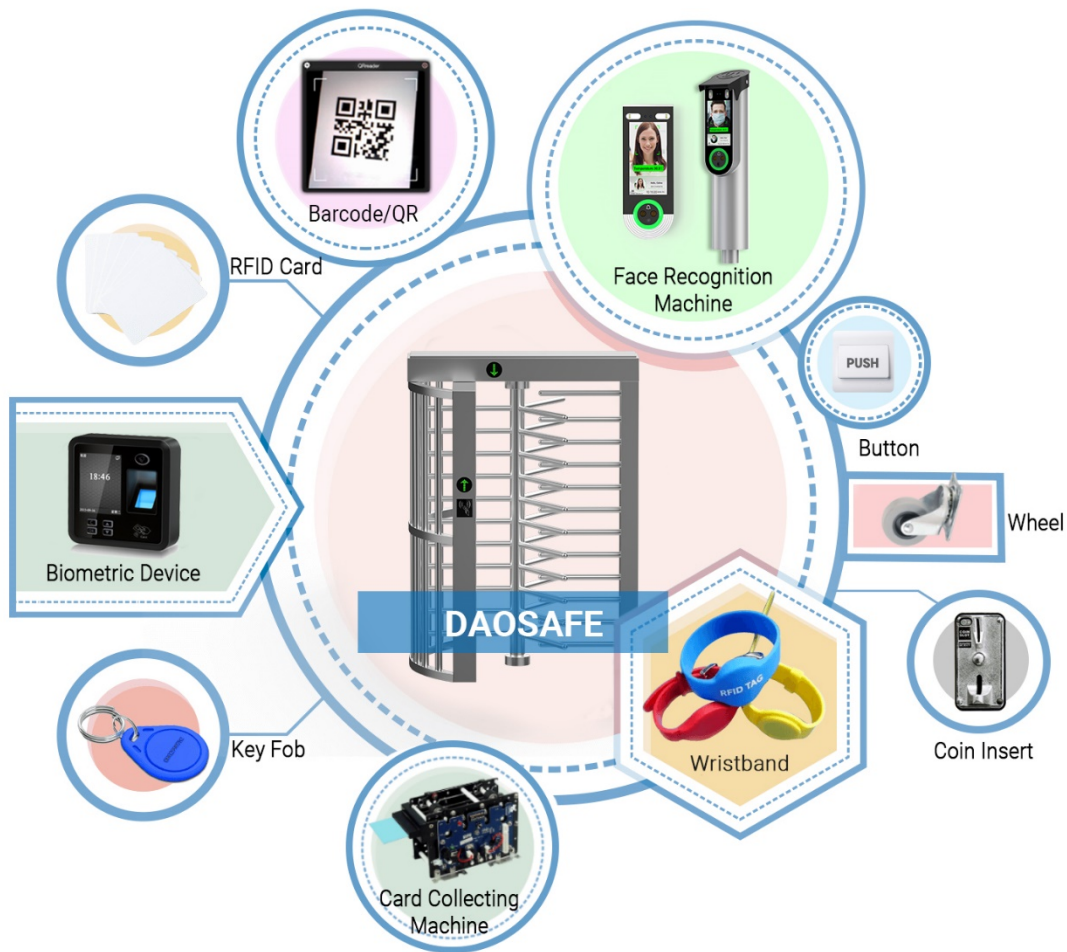

- **Face Recognition**
Dynamic face recognizes, non-contact and trendy solutions
- **Barcode /QR scanner**
Connect with mini PC or access controller to use
Support phone or paper Barcode/QR
- **RFID Card**
All kinds of RFID card reader, such as
Mifare, EM cards, HID card, Key Fob, Wristband...
- **Biometric Device**
Support Fingerprint, RFID card, password
Popular and secure access control solutions
- **Key Fob**
RFID type, mainly use in apartment
- **Card Collector Machine**
The solution is mainly used in park, building for visitor
- **Wristband**
RFID type, mainly used in swing pool and gym
- **Coin Insert**
The solution is mainly for bus stations or toilet
- **Wheel**
Integrated on turnstile for movable and portable
- **Button**
Exit by freely passing/ push button
- **3rd Party Access Controller**
Any 3rd party access controller can integrate
with all our turnstiles



Full Height Turnstile DS411 is a single door type with 304/316SS material, which is ideal for using at indoor and outdoor environments and usually work with pedestrian gate and railings, besides card access control system, also can integrated with fingerprint, QR code, facial recognition...



System Integration Figure

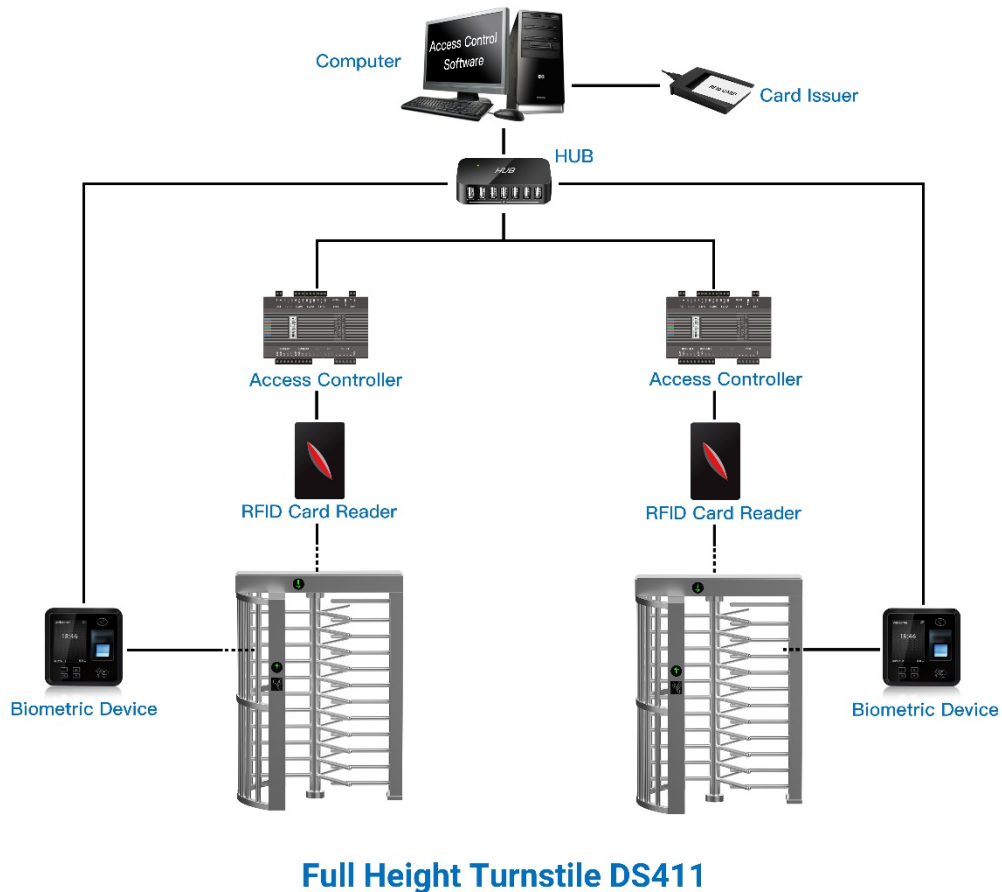

REMARK:

- The turnstile circuit board support to work with any relay signal, and support to integrated with any 3rd party access control system: RFID, BIOMETRIC, QR/BARCODE and so on.
- Multiple access controller board can be connected by TCP/IP through net cable, control by central computer.
- The turnstile circuit board is also with RS232 output, it can connect with mini PC. Turnstile will open once received simple code by computer, which is suitable for the complicated like ticketing system solution.

Full height turnstile is for maximum security in all type turnstiles. The most obvious feature of that is a security capability with 304/316 stainless steel framework to resist harsher circumstances.

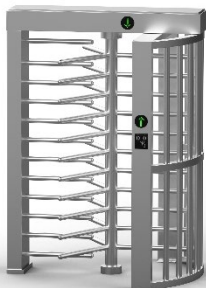

DS411 Single Door

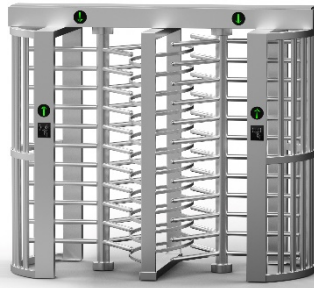

DS412 Double Door



Pedestrian Gate and Railings