



SAFETY  
LEVEL

AESTHETICS

COSTING

## Description

- Optical swing turnstile with 120mm cabinet is an elegant and slim solution for access control.
- The white tempered glass side panels with dazzling LED light which are more attractive and impressive, easily to catch pedestrian's eyes and enhance the artistry of the sites.
- The body is made of brushed stainless steel which is robust, rigid, anti-rust, waterproof and durable. The black tempered glass on the card panel which are firm and solid, not easy to be scratched.
- Waterproof: IP65 level, no afraid of water or rain. It is ideal for both indoor and outdoor settings.
- It has standard relay signal, which can be integrated with any kind of third-party access control system (e.g.: RFID, Fingerprint and Biometric reader device).
- In case of emergency, the arms will open automatically to allow free passage when power off.
- It support standard and handicapped type with wide passageway, wheelchair, and pedestrian with large luggage can pass.
- Application: suitable for any high-end sites, such as government building, chamber, bank, gym, hotel, shopping mall, office building and so on.

## Features

- ✓ Long-life performance, high operation dependability and fast response.
- ✓ The whole system runs smoothly, low noise, no mechanical impact.
- ✓ Single directional or Bi-directional is selectable.
- ✓ Automatic reset function: swing arms will lock automatically within 5s (can be setting) if passenger delay to entry.
- ✓ When power is off, swing arms will open automatically, which is complying with fire safety requirements.
- ✓ LED indicator (red "—" means no entry; green → means entry).
- ✓ Infrared sensor alarm functions, in case of illegal intrusion and reverse intrusion.
- ✓ Anti-intrusion function, the speed gate is locked automatically until valid opening signal input.
- ✓ Anti-reverse function, the turnstile alarms if someone wants to entry in the reverse direction.
- ✓ Anti-trailing function, the speed gate alarms if someone wants to burst in without permission.
- ✓ Anti-collision and anti-kick function, it designed with consolidated and more durable mechanism, will not break even someone collide it.
- ✓ Mechanism self-protection: the arm will reset automatically if is off position. It's movement will not be broken or damaged even after hit.
- ✓ It has the fastest open and close speed rate and can be adjusted.
- ✓ Easy to install and maintain.
- ✓ 3-year warranty support.



## SWING TURNSTILE HIGHLIGHTS

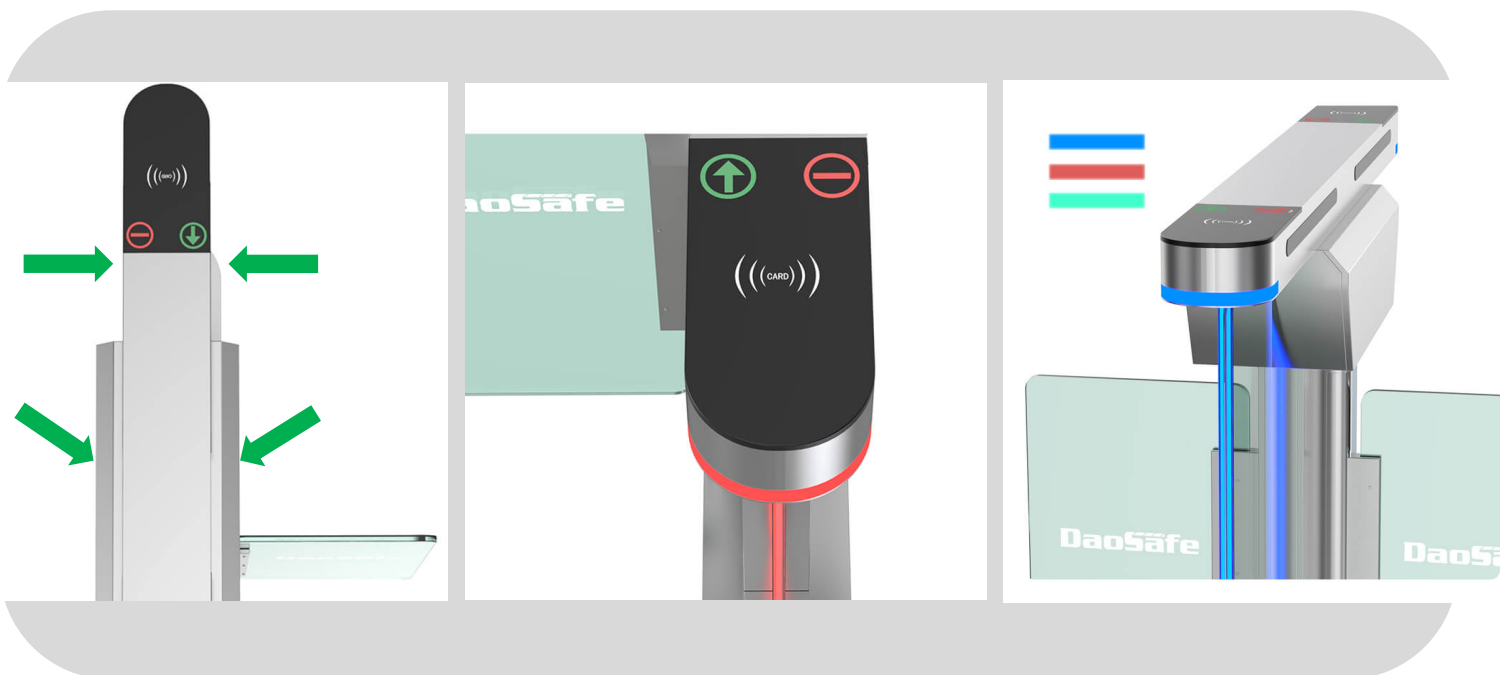

120mm slim cabinet, waterproof

Tempered glass swipe window

Blue, red and green LED light bar

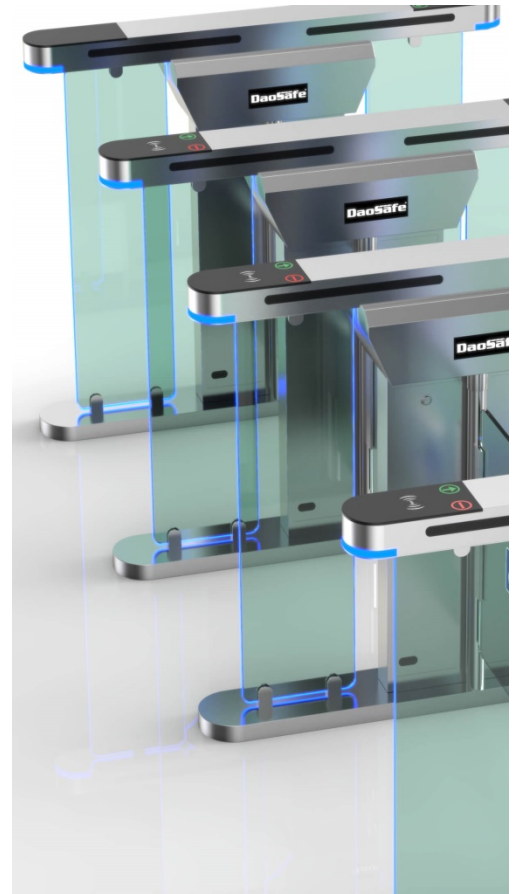
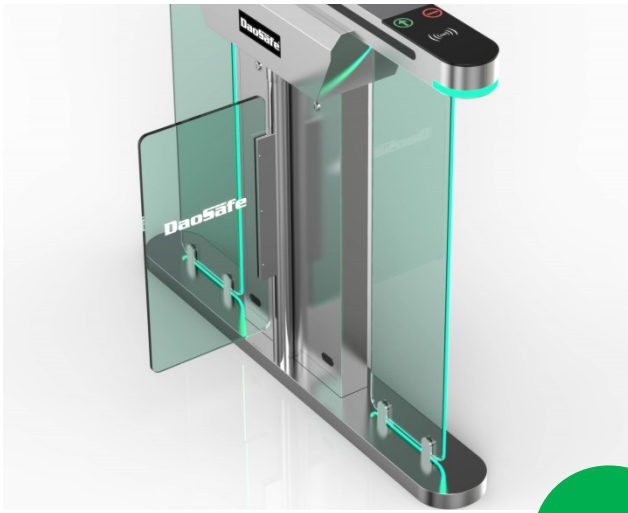

NEW



## MODEL DS218

Elegant, Slim, Anti-rust, Waterproof and Fast Speed (0.2s)

- Super slim cabinet: only 120mm, provide a cozy visual effect.
- The white tempered glass on the cabinet with impressive red, green and blue 3 colors lighting change.
- The black tempered glass on the card panel which are firm and solid, not easy to be scratched.
- Waterproof: IP65 level, no afraid of water or rain.

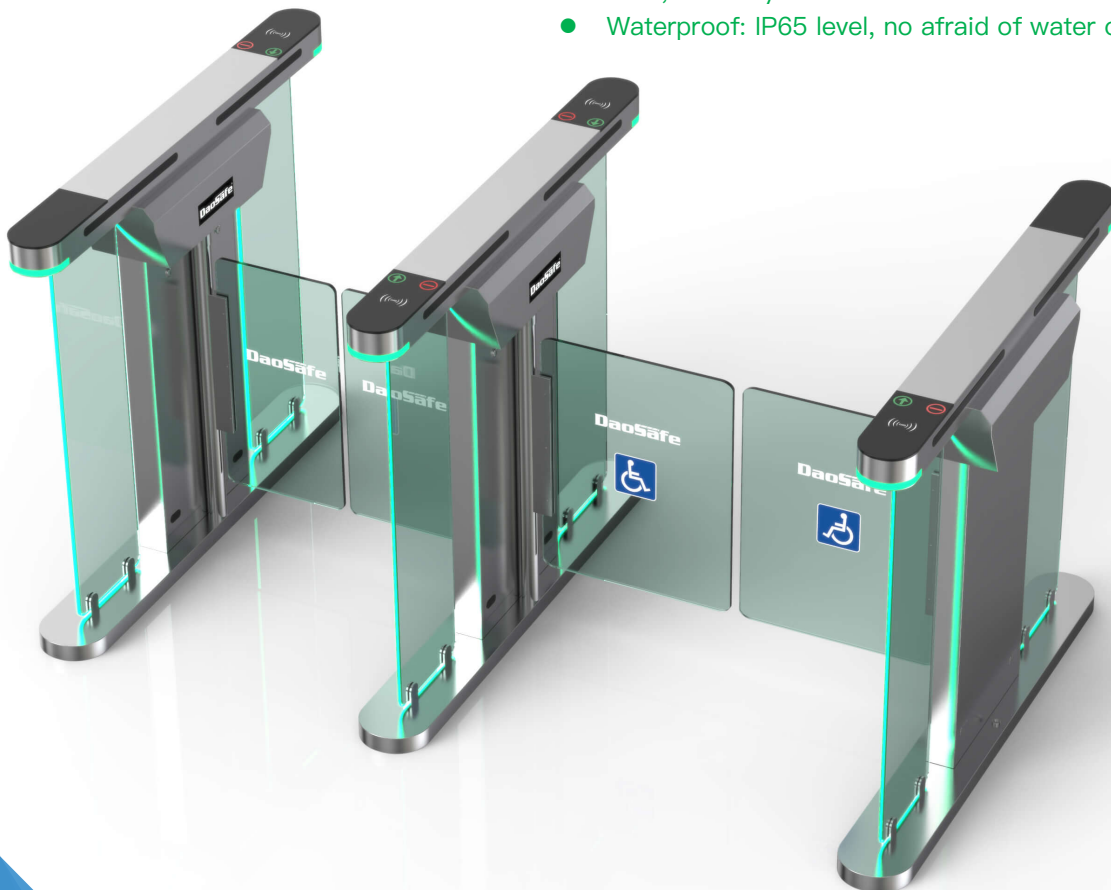

# Specification

Model No.	DS218
Type	Optical Swing Turnstile
Brand	Daosafe
Framework Material	304 Stainless steel+ Plexiglas glass arm+ tempered glass side panels with dazzling LED light
Arm material	Plexiglas-transparency
Dimension	1200 *120 * 1020mm
Net Weight	70kg/pcs (single core), 80kg/pcs (double core)
Passage Width	600mm( standard), 900mm( handicap)
Passing Direction	Single directional / Bi-directional
MCBF	12 million
Power Supply	AC220V/110V, 50/60Hz
Operation Voltage	24V DC
Power Consumption	40W
Operation Temperature	-20 °C – 75 °C
Operation Humidity	0 ~ 95% (No freeze)
Working Environment	Indoor / Outdoor (IP65)
Flow Rate	45-55 people per minute
LED Indicator	Two LED indicators on top: green “→” entry. red “—” no entry
Infrared Sensor	6 pairs(4pairs on the top +2 pairs on the below)
Emergency	Automatic arm open when power off
Flexibility	Integrate with any access control

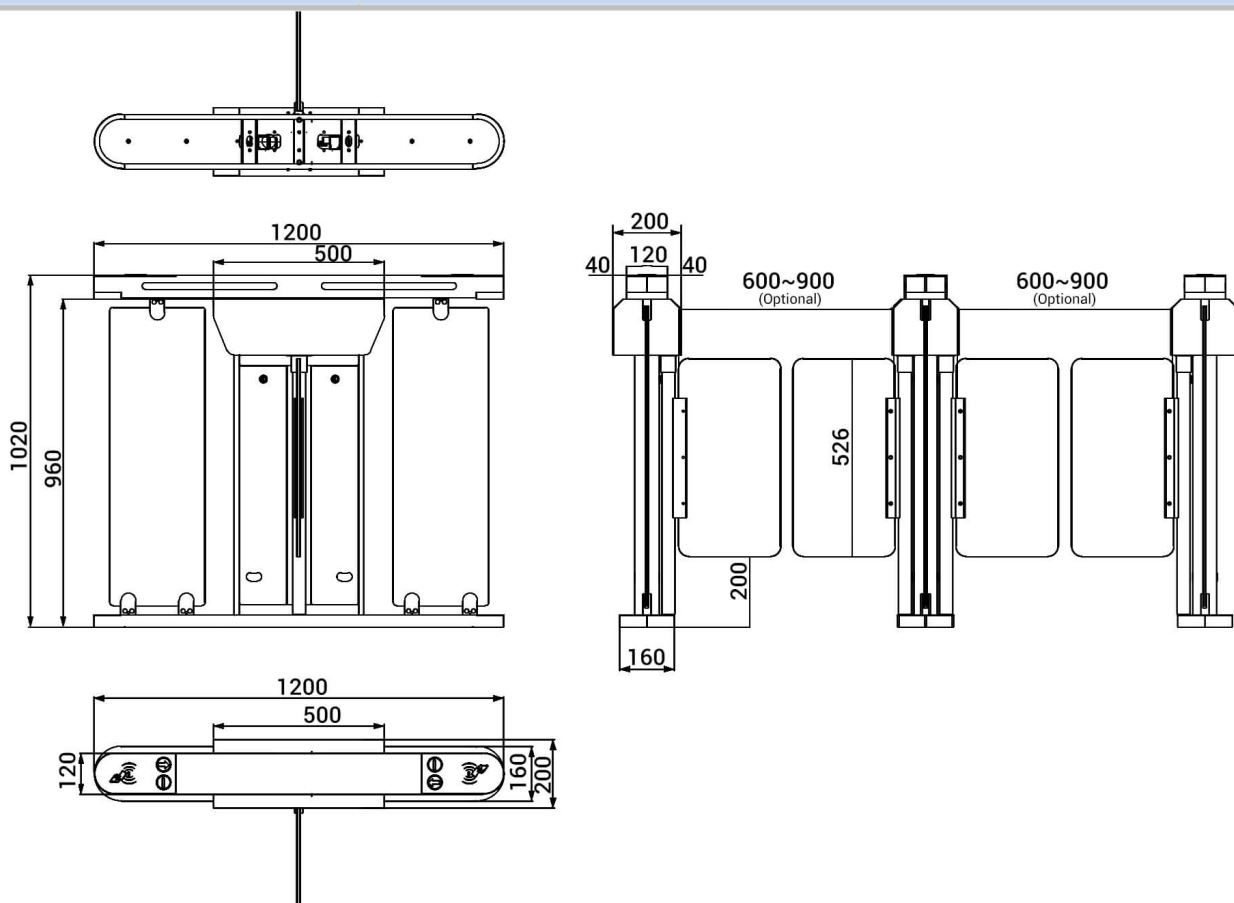



## WIDE RANGE INTEGRATION



- Face Recognition**  
 Dynamic face recognizes, non-contact and trendy solutions
- Barcode /QR scanner**  
 Connect with mini PC or access controller to use  
 Support phone or paper Barcode/QR
- RFID Card**  
 All kinds of RFID card reader, such as  
 Mifare, EM cards, HID card, Key Fob, Wristband...
- Biometric Device**  
 Support Fingerprint, RFID card, password  
 Popular and secure access control solutions
- Key Fob**  
 RFID type, mainly use in apartment
- Card Collector Machine**  
 The solution is mainly used in park, building for visitor
- Wristband**  
 RFID type, mainly used in swing pool and gym
- Coin Insert**  
 The solution is mainly for bus stations or toilet
- Wheel**  
 Integrated on turnstile for movable and portable
- Button**  
 Exit by freely passing/ push button
- 3rd Party Access Controller**  
 Any 3rd party access controller can integrate with all our turnstiles

# DS218 Anti-rust and Waterproof

It is ideal for both indoor and outdoor settings



## DS218 Working With Disabled Channel Solution

Optical Swing Turnstile DS218 with IP65 level, waterproof, no afraid of water or rain. Which is provides an artistic and high artwork solution for access control solution at sites with high aesthetic requirements, such as office, hotel, bank and chamber....





# System Integration Figure

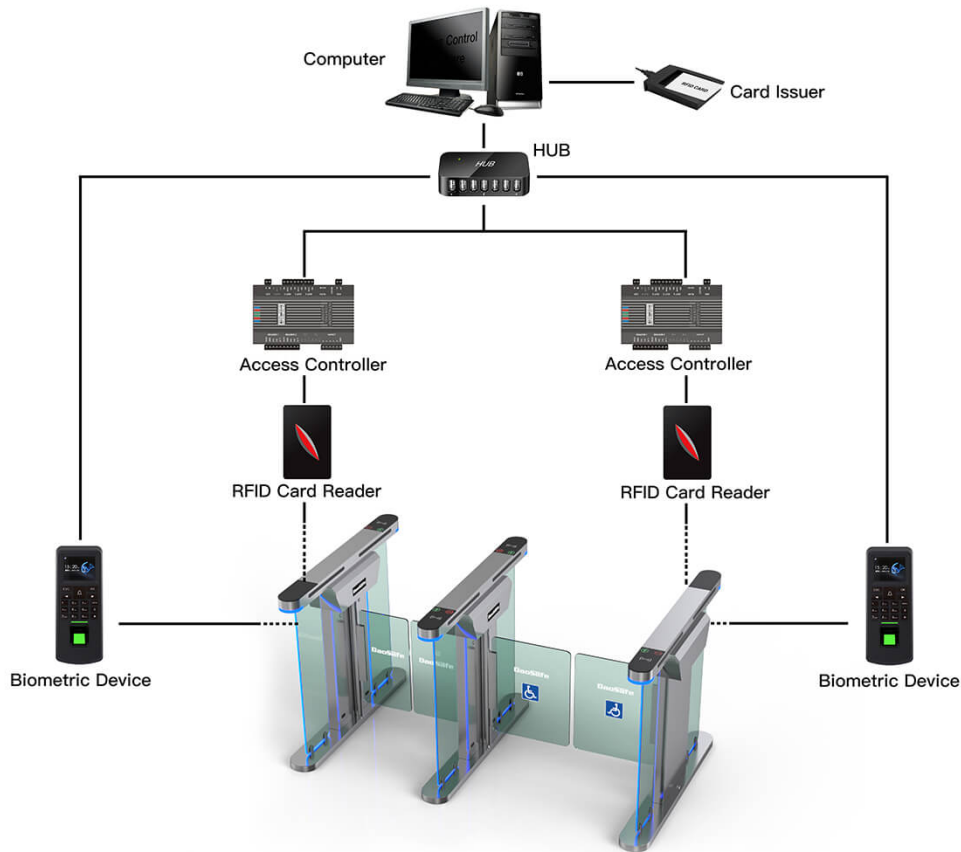

Optical Swing Turnstile DS218

## REMARK:

- The turnstile circuit board support to work with any relay signal, and support to integrated with any 3rd party access control system: RFID, BIOMETRIC, QR/BARCODE and so on.
- Multiple access controller board can be connected by TCP/IP through net cable, control by central computer.
- The turnstile circuit board is also with RS232 output, it can connect with mini PC. Turnstile will open once received simple code by computer, which is suitable for the complicated like ticketing system solution.

The advantage of swing turnstile is that the passage width can reach to 600mm-900mm, which is suitable for handicapped person or pedestrians with luggage. The turnstile is usually used in high-grade occasion.

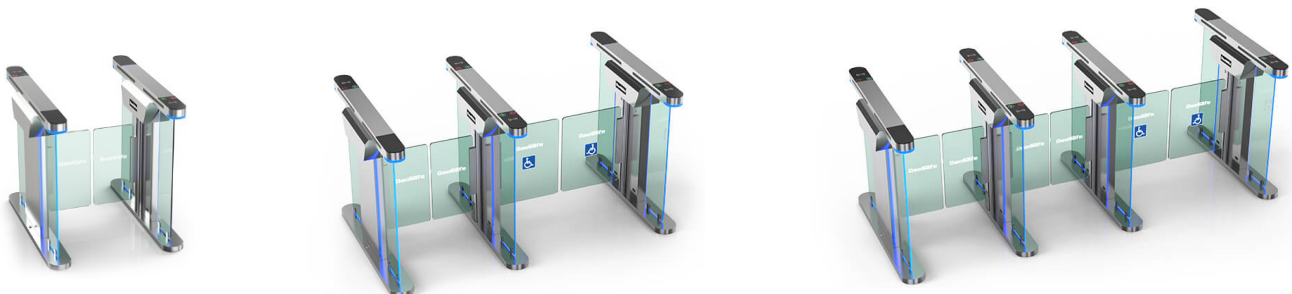

One Lane

Two Lanes

Three Lanes