



DS7000
Speed Gate
SINGLE / BI-DIRECTION

SAFETY
LEVEL

AESTHETICS

COSTING

Description

- Speed gate is to control pedestrian entry or exit in restricted areas, usually used in high pedestrian traffic flow in both directions.
- The body is made of brushed stainless steel which is robust, rigid, anti-rust, waterproof and durable.
- It is ideal for both indoor and outdoor settings.
- It has standard relay signal, which can be integrated with any kind of third-party access control system (e.g.: RFID, Fingerprint and Biometric reader device).
- It supports any type of external device solution. (e.g.: Display, Counter, Reader, Face recognition, Push button, Card collector, RFID Wristband Collector, Coin insert, Barcode/QR reader, Wheel).
- In case of emergency, the arms will open automatically to allow free passage when power off.
- It support standard and handicapped type with wide passageway, wheelchair, and pedestrian with large luggage can pass.
- It is suitable for areas with general pedestrian traffic (e.g.: Hotel, Gym, Building, Bank, Shopping mall, Reception Area).

Features

- ✓ Long-life performance, high operation dependability and fast response.
- ✓ The whole system runs smoothly, low noise, no mechanical impact.
- ✓ Single directional or Bi-directional is selectable.
- ✓ Automatic reset function: swing arms will lock automatically within 5s (can be setting) if passenger delay to entry.
- ✓ When power is off, swing arms will open automatically, which is complying with fire safety requirements.
- ✓ LED indicator (red × means no entry; green → means entry).
- ✓ Infrared sensor alarms function, in case of illegal intrusion and reverse intrusion.
- ✓ Anti-intrusion function, the speed gate is locked automatically until valid opening signal input.
- ✓ Anti-reverse function, the turnstile alarms if someone wants to entry in the reverse direction.
- ✓ Anti-trailing function, the speed gate alarms if someone wants to burst in without permission.
- ✓ Anti-collision and anti-kick function, it designed with consolidated and more durable mechanism, will not break even someone collide it.
- ✓ Mechanism self-protection: the arm will reset automatically if is off position. Its movement will not be broken or damaged even after hit.
- ✓ It has the fastest open and close speed rate, 0.2 second. The open and close speed rate can be adjusted.
- ✓ Easy to install and maintain.
- ✓ 3-year warranty support.



We don't only offer turnstile gates. We offer full access control solutions.



Specification

Model No.	DS7000
Type	Speed Gate
Brand	Daosafe
Framework Material	304 Stainless Steel+ Plexiglas Arm+ Full Tempered Glass on side
Dimension	1605 * 127 * 1000mm
Net Weight	75kg/pcs (single core), 85kg/pcs (double core)
Passage Width	600mm(standard), 1200mm(handicap)
Arm Height	900–1800mm (Max.)
Passing Direction	Single directional / Bi-directional
MCBF	10 million
Power Supply	AC220V/110V, 50/60Hz
Operation Voltage	24V DC
Power Consumption	40W
Operation Temperature	-20 °C – 75 °C
Operation Humidity	0 ~ 95% (No freeze)
Working Environment	Indoor / Outdoor (shelter)
Flow Rate	40–45 people per minute
LED Indicator	LED indicators on top: green → entry. red × no entry
Infrared Sensor	6 pairs(standard)
Emergency	Automatic arm open when power off
Communication	Dry contact, Relay signal, RS485

Short Glass Arm

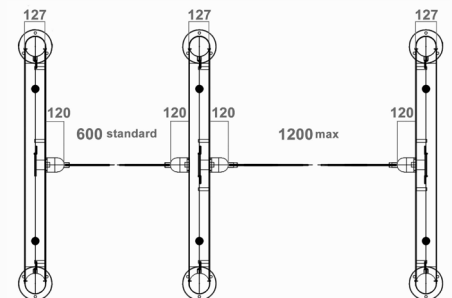
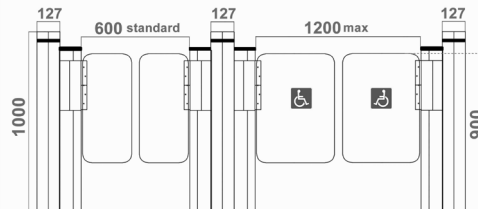
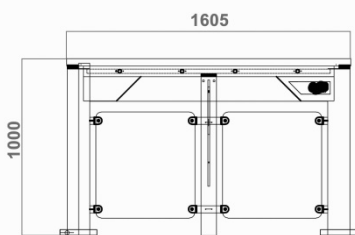

High Glass Arm

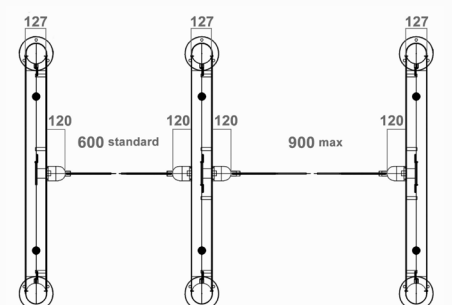
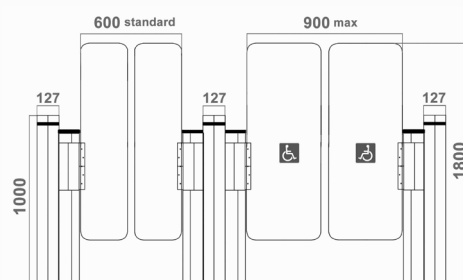
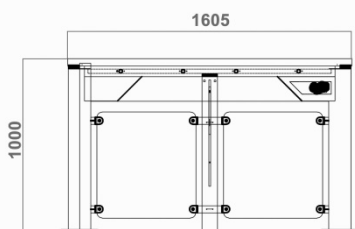

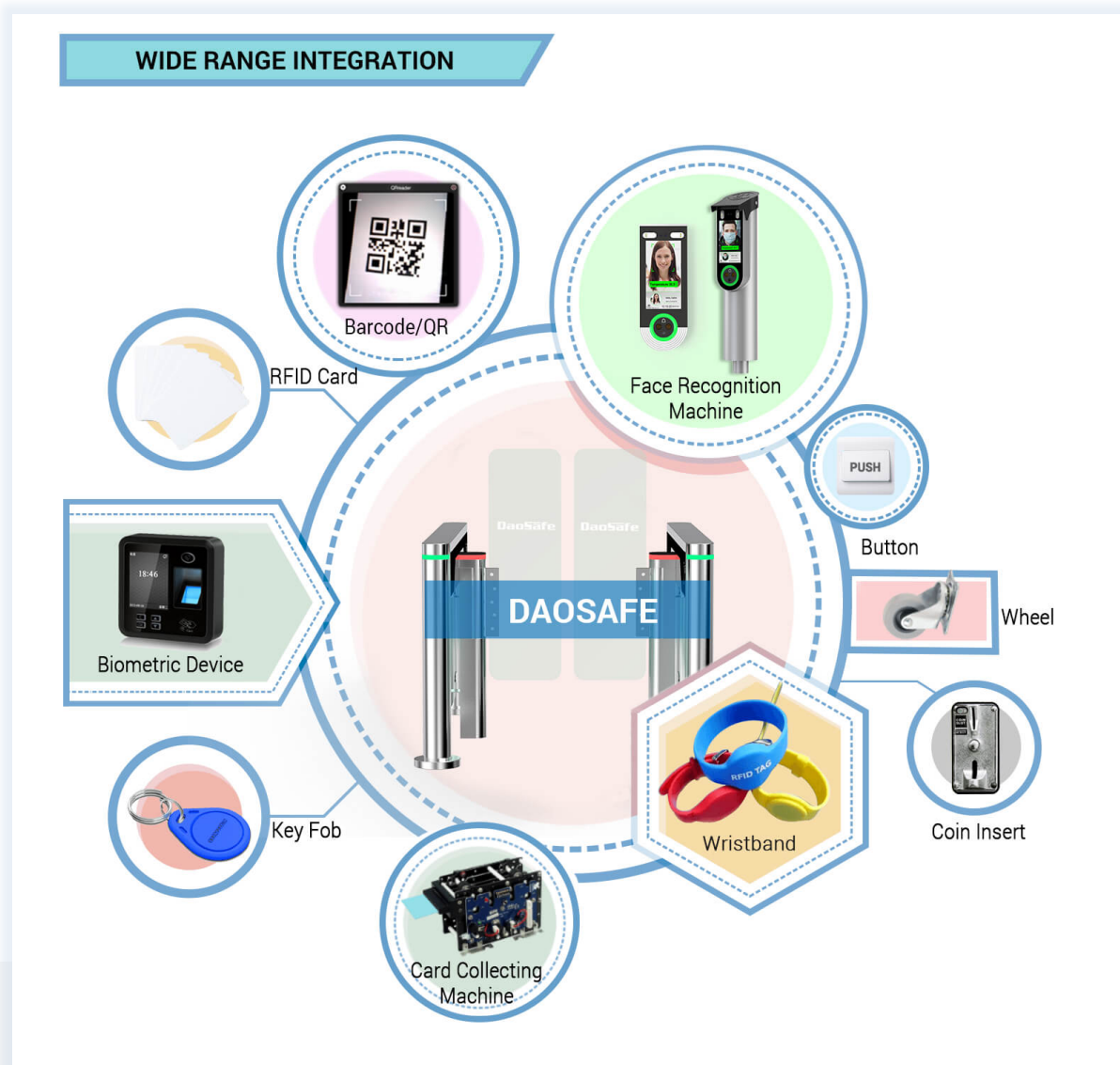

- Face Recognition**
 Dynamic face recognizes, non-contact and trendy solutions
- Barcode /QR scanner**
 Connect with mini PC or access controller to use
 Support phone or paper Barcode/QR
- RFID Card**
 All kinds of RFID card reader, such as
 Mifare, EM cards, HID card, Key Fob, Wristband...
- Biometric Device**
 Support Fingerprint, RFID card, password
 Popular and secure access control solutions
- Key Fob**
 RFID type, mainly use in apartment
- Card Collector Machine**
 The solution is mainly used in park, building for visitor
- Wristband**
 RFID type, mainly used in swing pool and gym
- Coin Insert**
 The solution is mainly for bus stations or toilet
- Wheel**
 Integrated on turnstile for movable and portable
- Button**
 Exit by freely passing/ push button
- 3rd Party Access Controller**
 Any 3rd party access controller can integrate with all our turnstiles

DS7000 working with different heights of glass arm



Speed Gate DS7000 passage width can reach to 600-1200mm, which is suitable for handicapped person or pedestrians with luggage. Also support the glass height can be extended to 1.8m, which can ensure higher security.



System Integration Figure

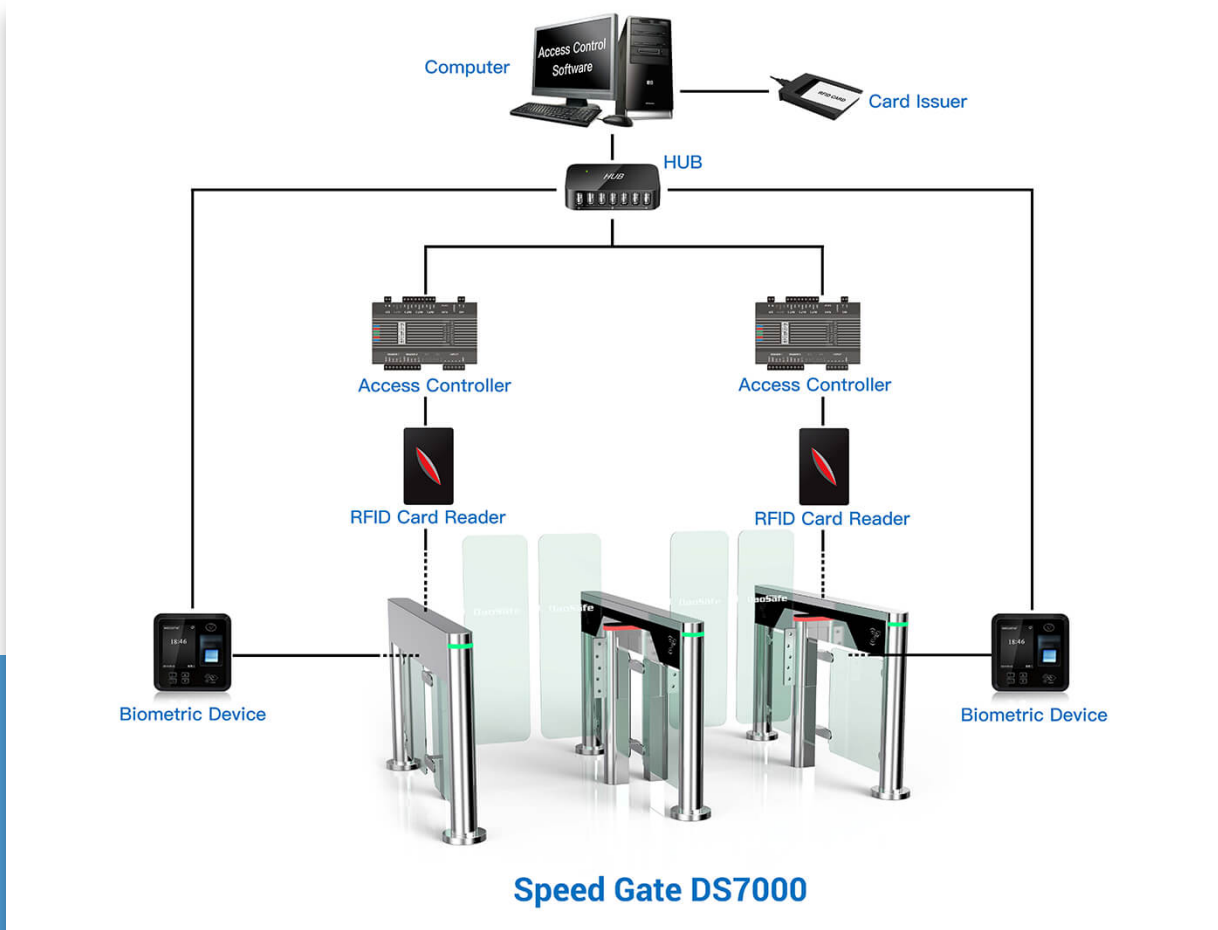

REMARK:

- The turnstile circuit board support to work with any relay signal, and support to integrated with any 3rd party access control system: RFID, BIOMETRIC, QR/BARCODE and so on.
- Multiple access controller board can be connected by TCP/IP through network cable, control by central computer.
- The turnstile circuit board is also with RS232 output, it can connect with mini PC. Turnstile will open once received simple code by computer, which is suitable for the complicated like ticketing system solution.

Speed gate is designed for elegant and luxury application to control access. Outstanding feature: Fast open and close speed and exceeding slim housing.



One Lane



Two Lanes



Three Lanes